

Las Bombas serie NM, B-NM, son conformes al Reglamento Europeo N. 547/2012 en vigor desde el 01.01.2013.

Materiales

Componentes	NM, NMD	B-NM, B-NMD
Cuerpo bomba	Hierro	Bronce
Acoplamiento	GJL 200 EN 1561	G-Cu Sn 10 EN 1982
Rodete	Latón P- Cu Zn 40 Pb 2 UNI 5705	
NM 17	Hierro GJL 200 EN 1561	Bronce G-Cu Sn 10 EN 1982
Eje	Acero al Cr AISI 430 Acero al Cr Ni AISI 303 de 1,1-1,5-2,2 kW	Acero al Cr Ni Mo AISI 316
Sello mecánico	Carbón - Cerámica - NBR	

Ejecución

Electrobombas centrífugas monobloc con acoplamiento directo motor-bomba y eje único.

NM: Con un rodete.

NMD: Con dos rodetes contrapuestos (con empuje axial equilibrado).

Orificios: Roscados UNI-ISO 228/1.

NM, NMD: Ejecución con cuerpo bomba y acoplamiento en hierro.

B-NM, B-NMD: Ejecución con cuerpo bomba y acoplamiento en bronce.

Las bombas en bronce se suministran totalmente pintadas.

Aplicaciones

- Para líquidos limpios sin partes abrasivas, y no agresivos para los materiales de la bomba (con partes sólidas hasta 0,2% máx).
- Para el aprovisionamiento de agua.
- Para instalaciones de calefacción, acondicionamiento, refrigeración y circulación.
- Para aplicaciones civiles e industriales.
- Para instalaciones contra incendios.
- Para irrigación.

Límites de empleo

Temperatura del líquido de -10 °C a +90 °C.

Temperatura ambiente hasta 40 °C.

Altura de aspiración manométrica hasta 7 metros.

Presión final máxima admitida en el cuerpo de la bomba 10 bar.

(16 bar para bombas NMD 25/190; NMD 32/210; NMD 40/180).

Servicio continuo.

Motor

Motor a inducción a 2 polos, 50 Hz (n = 2900 1/min).

NM, NMD: trifásico 230/400 V ± 10%, hasta 4 kW;

400/690 V ± 10%, de 5,5 a 9,2 kW;

NMM, NMDM: monofásico 230 V ± 10%, con protector térmico.

Aislamiento clase F. Protección IP 54.

Motor preparado al funcionamiento con convertidor de frecuencia a partir de 2,2 kW.

Clase alta eficiencia IE2 para motor trifásico a partir de 0,75 kW.

Ejecución según EN 60034-1; EN 60034-30.

EN 60335-1, EN 60335-2-41.

Otras ejecuciones bajo demanda

- Otras tensiones. - Frecuencia 60 Hz.
- Protección IP 55.
- Sello mecánico especial.
- Para líquidos o ambientes con temperaturas más elevadas o más bajas.
- Motor preparado al funcionamiento con convertidor de frecuencia hasta 1,5 kW.

Campo de aplicaciones n ≈ 2900 1/min

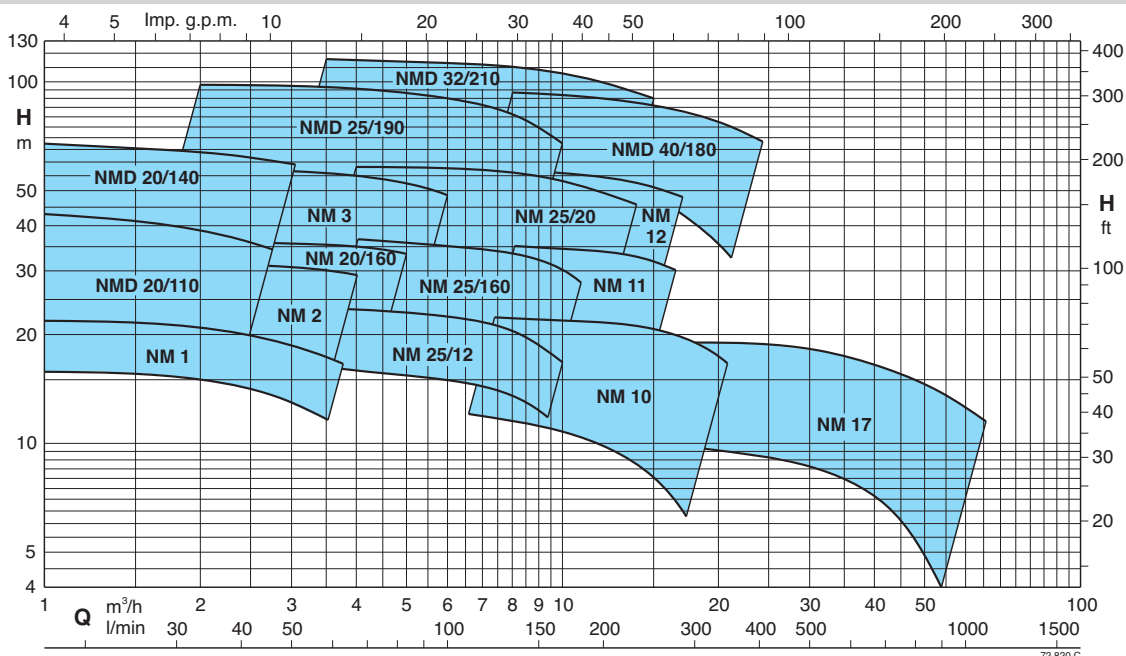

Prestaciones n ≈ 2900 1/min

	NM	P ₂		Q m ³ /h l/min	Q															
		kW	HP		1	1,2	1,5	1,89	2,4	3	3,6	4,2	4,8	5,4	6	6,6	7,5	8,4		
					16	20	25	31,5	40	50	60	70	80	90	100	110	125	140		
	NM 1/AE●	0,37	0,5	H m	22	21,6	21,3	20,9	20,3	19,4	18,1	16,3								
	NM 2/B/A●	0,55	0,75		27	26,5	26	25,5	25	24	23	22	20							
	NM 2/S/A●	0,55	0,75		31	30,5	30	29	27,5	25,5	23,5	20	16							
	NM 2/A/A●	0,75	1		33,5	33	32,5	32	31,5	30,5	29,5	28,5	27	26	24					
	NMM 3/CE	1,1	1,5			37,5	37,5	37	36,5	36	35	34	32							
	NM 3/CE	1,1	1,5			37,5	37,5	37	36,5	36	35	34	32	30,5	28,5					
	NMM 3/BE	1,5	2			42	42	41,5	41	40,5	40	39	37	35	32					
	NM 3/BE	1,5	2			47	47	46,5	46	45,5	45	44	43	41,5	40	37,5	33	26		
	NMM 3/A	1,8	2,5			47,5	47,5	47	46,5	46	45,5	44,5	43,5	42	40,5	38	33,5	26,5		
	NM 3/A/A	2,2	3			56	55,5	55,5	55	54,5	53,5	52,5	51,5	50	48	46	42	36		

B-NM B-NMD	NM NMD	P ₂		Q m ³ /h l/min	Q															
		kW	HP		1	1,2	1,5	1,89	2,4	3	3,6	4,2	4,8	5,4	6	6,6	7,5	8,4		
					16	20	25	31,5	40	50	60	70	80	90	100	110	125	140		
B-NMD 20/110B/A●	NMD 20/110B/A●	0,45	0,6	H m	33	32	31	29	26,5	23	18									
B-NMD 20/110Z/A●	NMD 20/110Z/A●	0,55	0,75		37	36	35	33	30,5	27,5	23	18								
B-NMD 20/110A/A●	NMD 20/110A/A●	0,75	1		43	42	40,5	39	36,5	33	29	25								
B-NMDM 20/140BE	NMDM 20/140BE	1,1	1,5		52	51,5	51	50	48,5	47	45									
B-NMD 20/140BE	NMD 20/140BE	1,1	1,5		53	52,5	52	51	50	48	46	43,5	40							
B-NMDM 20/140AE	NMDM 20/140AE	1,5	2		57,5	57	56,5	55,5	54	51,5	49	46	43	40	36					
B-NMD 20/140AE	NMD 20/140AE	1,5	2		67	66,5	66	64,5	63	61,5	59	57	53,5	50	46					
B-NM 20/160BE●	NM 20/160BE●	0,75	1					30,5	30	29,5	28,5	27,5	26,5	25,5	24	22				
B-NM 20/160AE●	NM 20/160AE●	1,1	1,5					36	35,5	35	34,5	33,5	32	30,5	29	27				

B-NM B-NMD	NM NMD	P ₂		Q m ³ /h l/min	Q															
		kW	HP		2,4	3	3,6	4,8	6	6,6	7,5	8,4	9,6	10,8	12	13,2	15	16,8	18	
					40	50	60	80	100	110	125	140	160	180	200	220	250	280	300	
B-NM 25/12B/A●	NM 25/12B/A●	0,55	0,75	H m	20	19,9	19,8	19,3	18,5	18	17,3	16,3	15	13,2	11					
B-NM 25/12A/A●	NM 25/12A/A●	0,75	1		23,5	23,4	23,3	22,9	22,1	21,7	20,9	20	18,7	17,1	15,2					
B-NM 25/160BE●	NM 25/160BE●	1,1	1,5			31	30,7	30	28,5	28	27	26	23							
B-NM 25/160AE●	NM 25/160AE●	1,5	2			36,5	36,2	35,5	34,5	34	33,5	32,5	31	28,5	26					
B-NM 25/200B/A	NM 25/20B/A-M	2,2	3			49,9	49,5	48,8	48,2	47,8	47,4	46,8	45,9	45,1	44,1	42,8	40,6	37,3		
B-NM 25/200A/A	NM 25/20A/A-M	3	4			57	56,7	56,3	56	55,8	55,4	55,1	54,4	53,8	52,8	51,8	49,6	46,6		
B-NM 25/200S/A	NM 25/20S/A	4	5,5			57,8	57,7	57,4	57,2	57	56,7	56,4	55,8	55,2	54,3	53,3	51,2	48,2		
B-NMD 25/190C/A	NMD 25/190C/A	2,2	3			62	60,5	59	55,5	51	48,5	44	38							
B-NMD 25/190B/A	NMD 25/190B/A	3	4			76	75	74	70	66	64	60	54	46						
B-NMD 25/190A/A	NMD 25/190A/A	4	5,5			98	97	96	93,5	90	88	84	79	70						

	NM	P ₂		Q m ³ /h l/min	Q															
		kW	HP		6,6	7,5	8,4	9,6	10,8	12	13,2	15	16,8	18,9	21	24	27	30		
					110	125	140	160	180	200	220	250	280	315	350	400	450	500		
	NM 10/FE●	0,55	0,75	H m	12,5	12,5	12	11,5	11	10	9	7,5								
	NM 10/DE●	0,75	1		18	18	17,5	17	16,5	16	15,5	14								
	NM 10/AE●	1,1	1,5		23	23	22,5	22	21,5	21	20,5	19								
	NM 10/SE●	1,5	2		23,5	23,5	23	22,5	22	21,5	21	20,5	19	18,5	16,5	13				
	NMM 11/BE	1,5	2		26,5	25,5	25	24	23	22,5	21,5	19,5	17,5							
	NM 11/BE	1,5	2		29,5	29,5	29	28,5	27,5	27	26	25*	22,5*							
	NM 11/A/A	2,2	3		35,5	35,5	35	34,5	34	33,5	33	32*	30*							
	NM 12/D/A	2,2	3		38	37,5	37	36	35	33,5	32									
	NM 12/C/A	3	4		45	44,5	44	43,5	42,5	41	40	38	36							
	NM 12/A/A	4	5,5		57,5	57	56	55,5	55	54,5	53,5	51,5	49							

Prestaciones n ≈ 2900 1/min

1

B-NMD	NMD	P ₂		Q m ³ /h l/min	H															
		kW	HP		5,4	6	6,6	7,5	8,4	9,6	10,8	12	13,2	15	16,8	18,9	21	24		
B-NMD 32/210D/A	NMD 32/210D/A	4	5,5	H m	71	69	67,5	65	62,5	58	53	46	37*							
B-NMD 32/210C/A	NMD 32/210C/A	5,5	7,5		84	83	82	81	79	76	73	69	64*	54*						
B-NMD 32/210B/A	NMD 32/210B/A	7,5	10		104	103	102	100	98	95	92	88	84*	76*						
B-NMD 32/210A/A	NMD 32/210A/A	9,2	12,5		114	113	112	110	108	105	103	99	96*	90*						
B-NMD 40/180D/A	NMD 40/180D/A	4	5,5					60	59,5	57	56	53	51,5	48	44	39	34*	25*		
B-NMD 40/180C/A	NMD 40/180C/A	5,5	7,5					69	68	67	66	64,5	63	60	57	53	48*	40*		
B-NMD 40/180B/A	NMD 40/180B/A	7,5	10					87	86	85	84	82,5	81	78	75	71	66*	59*		
B-NMD 40/180A/A	NMD 40/180A/A	9,2	12,5					94	93	92	91	89,5	88	85	82	78	74*	67*		

B-NM	NM	P ₂		Q m ³ /h l/min	H													
		kW	HP		21	24	27	30	33	37,8	42	48	54	60	66	75	84	96
B-NM 17/HE●	NM 17/HE●	1,1	1,5	H m	9,5	9,2	9	8,6	8,2	7,5	6,7	5,5	3,5*					
B-NM 17/GE●	NM 17/GE●	1,5	2		12	11,7	11,5	11,2	11	10,3	9,7	8,5	7*	4*				
B-NM 17/F/A	NM 17/F/A	2,2	3			16	16	15,5	15	14,5	14	13	11,5*	10*	8*			
B-NM 17/D/A	NM 17/D/A	3	4				18	18	17,5	17	16,5	15,5	14*	13*	11,5*			

NM, NMD
B-NM, B-NMD

Ejecución normal.
Ejecución en bronce.

P₂ Potencia nominal del motor.
H Altura total en m.

● Con motor monofásico = NMM - NMDM.
* Altura máxima de aspiración manométrica 1-2 m.
Tolerancias según UNI EN ISO 9906:2012.

REGLAMENTO (EU) No 547/2012

- El valor de referencia para las bombas hidráulicas más eficientes es MEI ≥ 0,70;
- La eficiencia de una bomba con un impulsor recortado suele ser inferior a la de una bomba con el impulsor de diámetro completo. La reducción del impulsor adapta la bomba a un punto de trabajo fijado, que da lugar a un menor consumo energético. El índice de eficiencia mínima (MEI) se basa en el impulsor de diámetro completo;
- El funcionamiento de esta bomba hidráulica con puntos de trabajo variables puede resultar más eficiente y económico si se controla, por ejemplo, mediante el uso de un mando de regulación de velocidad que ajuste el trabajo de la bomba al sistema.

Intensidades nominales

P ₁ kW	P ₂		230 V 1~ IN A	IA/IN	P ₂				
	kW	HP			230 V Δ / 400 V Y 400 V Δ / 690 V Y			IA/IN	
						IN A	IN A	IN A	
0,62	0,37	0,5	3	2,7	0,37	0,5	2,3	1,3	3,8
0,72	0,45	0,6	3,6	2,9	0,45	0,6	2,3	1,3	3,5
0,91	0,55	0,75	4,5	3,1	0,55	0,75	3	1,7	4,3
1,2	0,75	1	5,8	3	0,75	1	3,7	2,2	3,9
1,6	1,1	1,5	7,4	3	1,1	1,5	4,6	2,7	5,6
2	1,5	2	9,2	3,8	1,5	2	7,5	4,3	5,5
2,5	1,8	2,5	11,2	4,5	2,2	3	9,15	5,3	7,4
					3	4	11,5	6,6	8,2
					4	5,5		9,6	7,6
					5,5	7,5		10,9	9,1
					7,5	10		14,3	9,1
					9,2	12,5		18,5	8,2

P₁ Máxima potencia absorbida.

P₂ Potencia nominal del motor.

IA/IN Intensidad de arranque / Intensidad nominal

Curvas Características $n \approx 2900$ 1/min

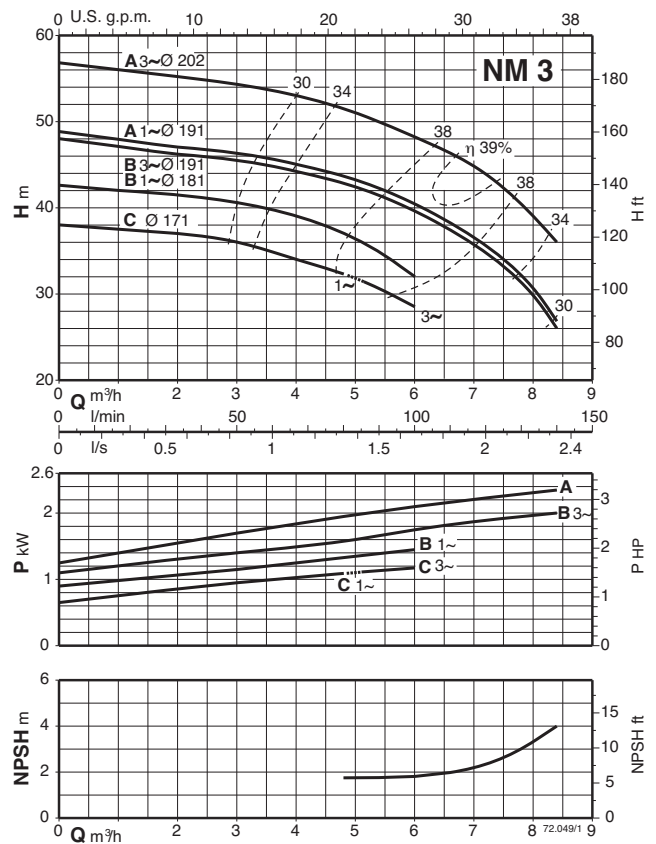
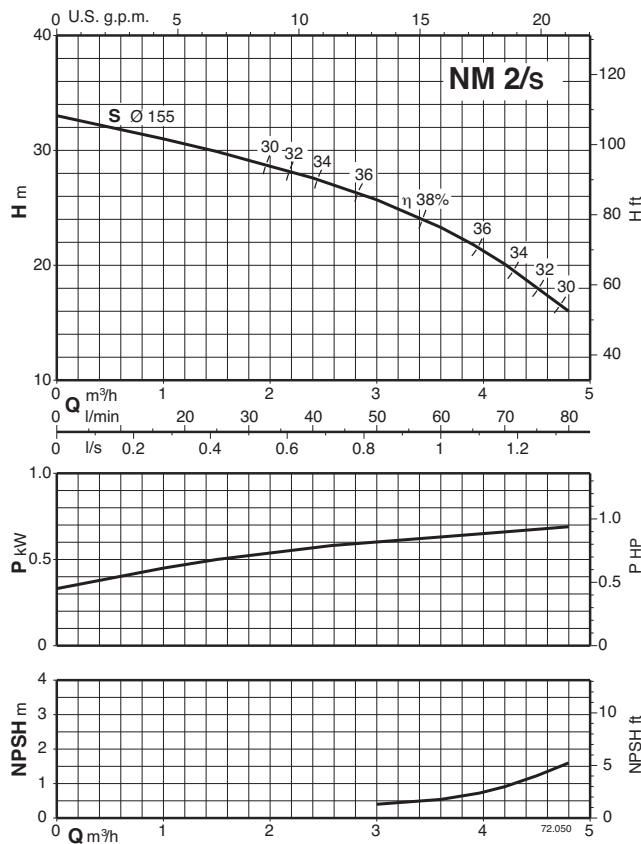
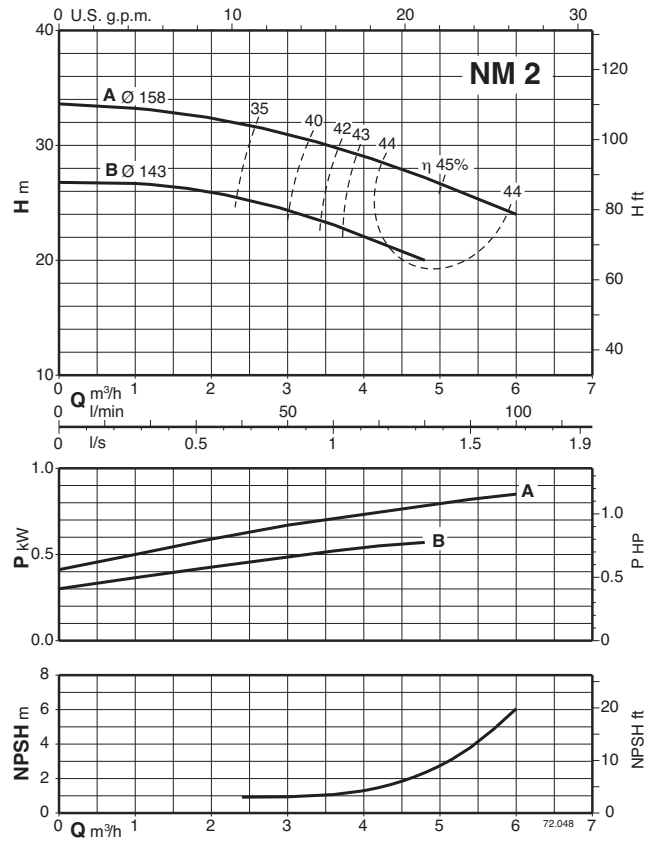
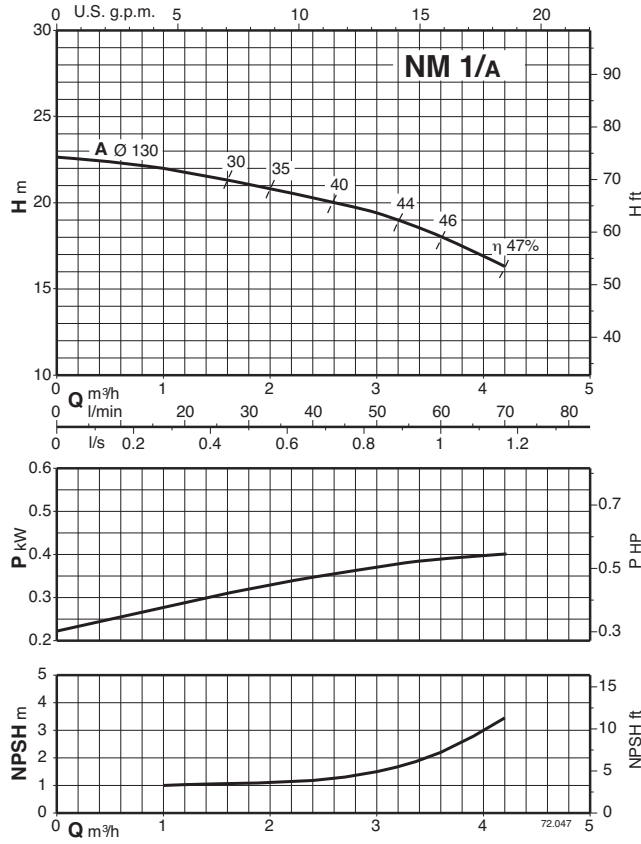

Curvas Características $n \approx 2900$ 1/min

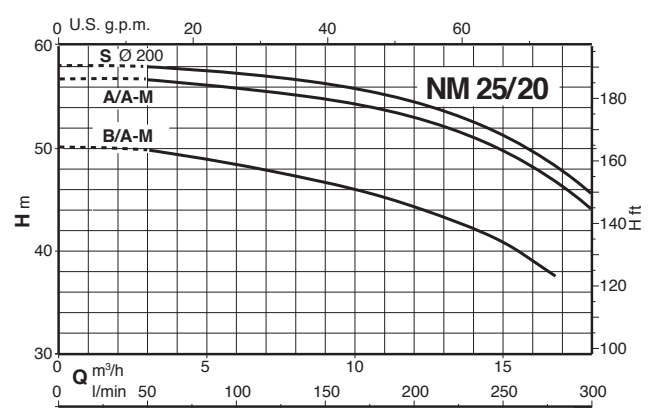
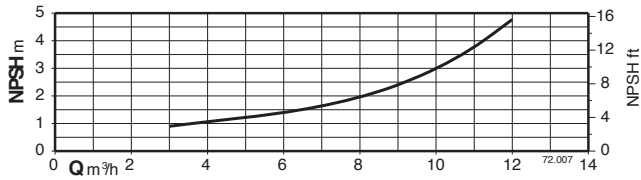
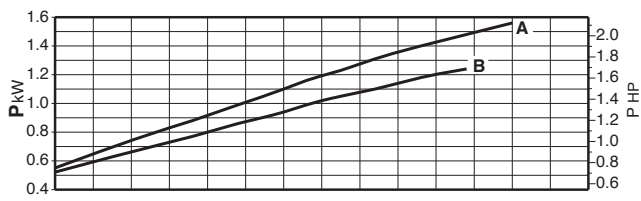
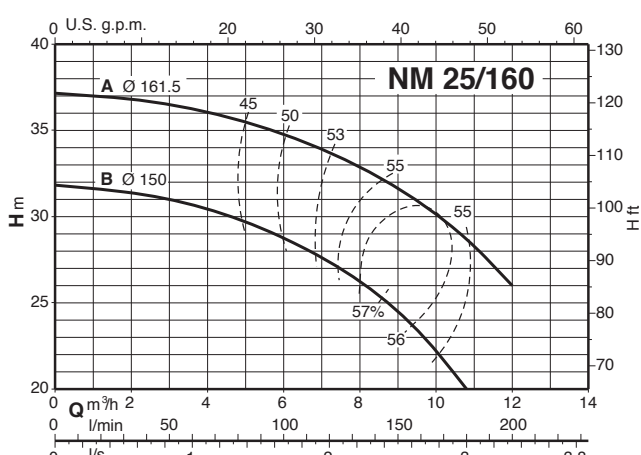
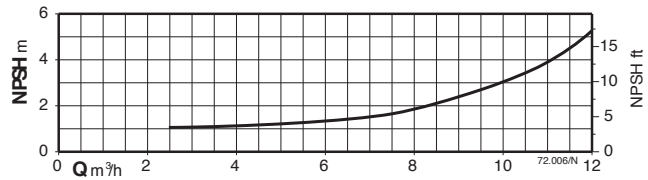
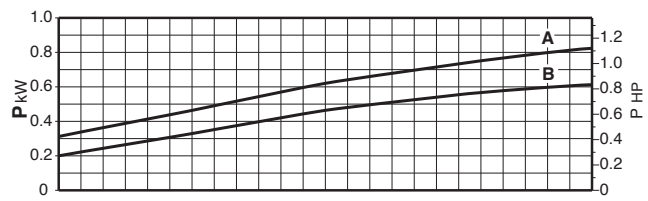
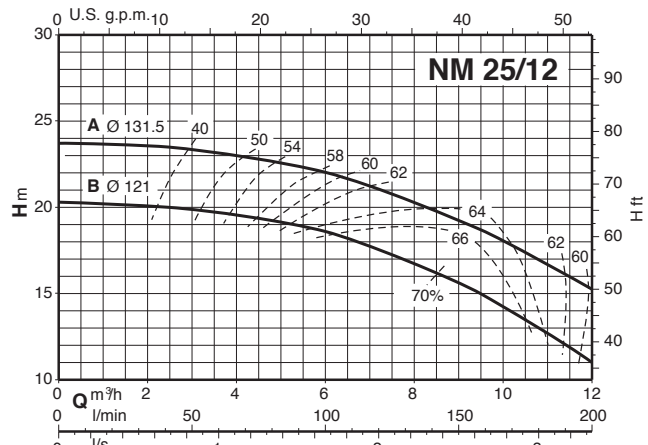
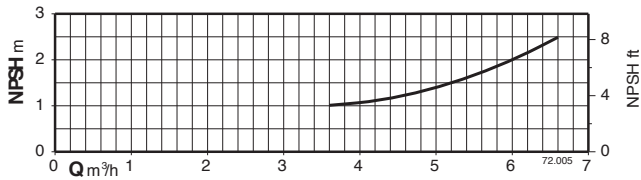
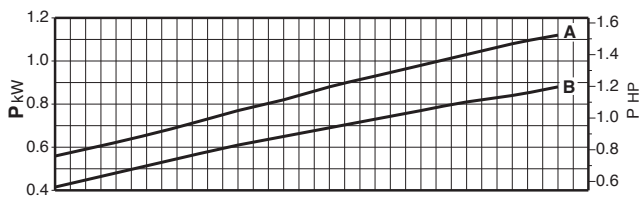
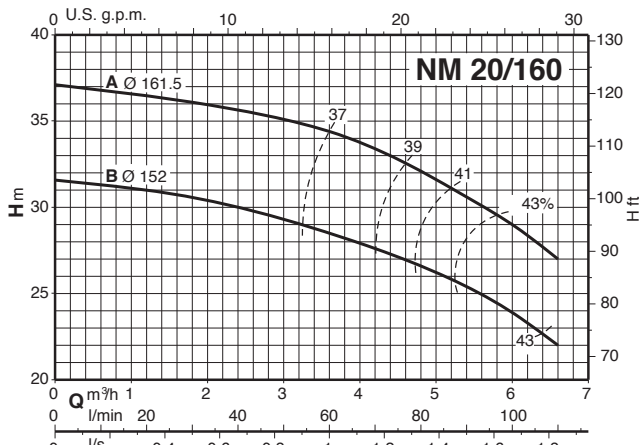

Curvas Características $n \approx 2900$ 1/min

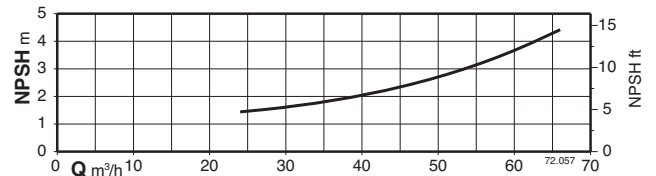
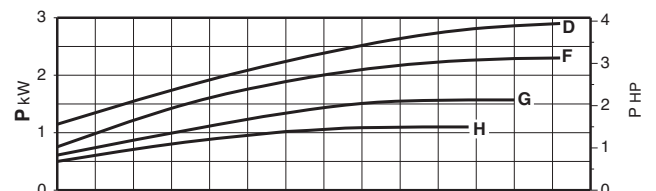
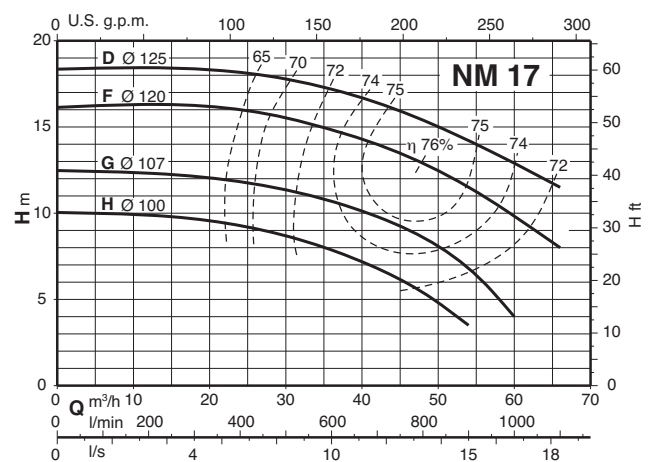
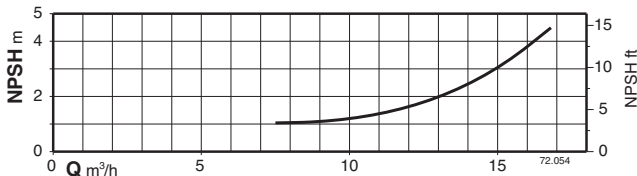
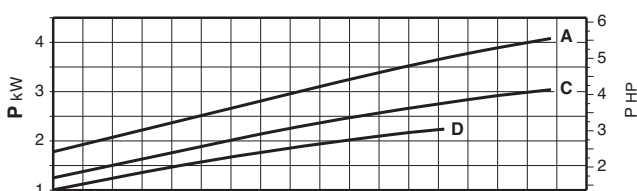
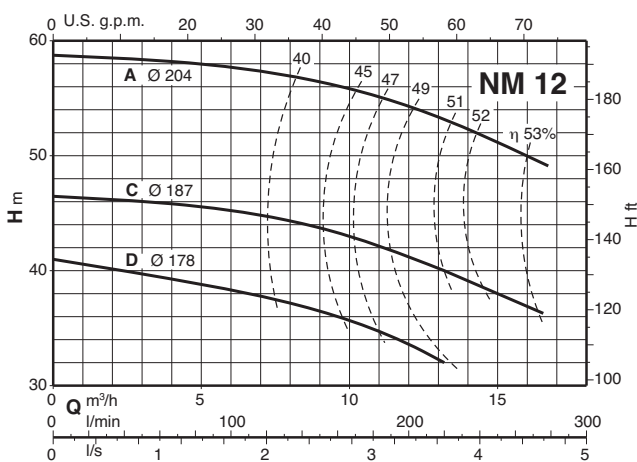
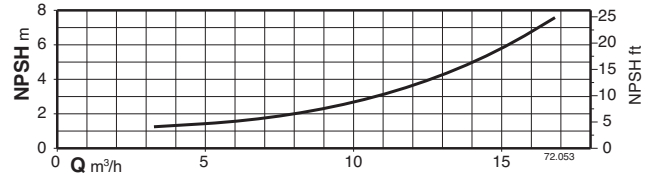
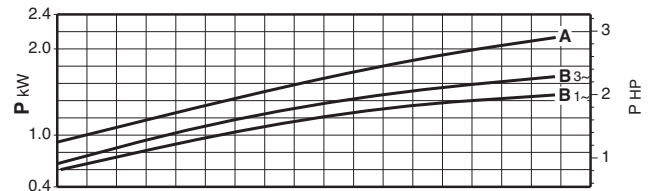
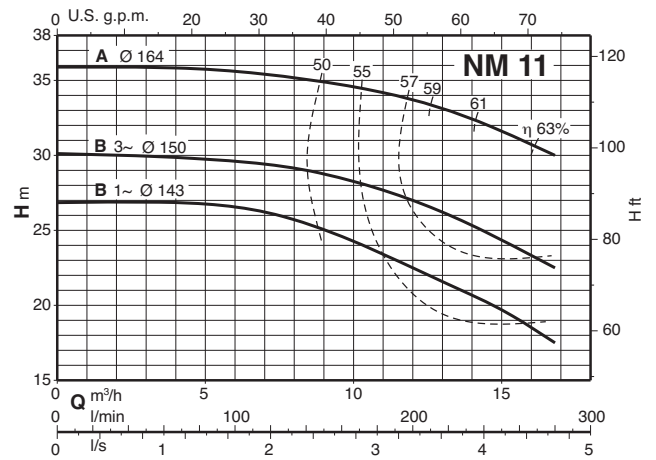
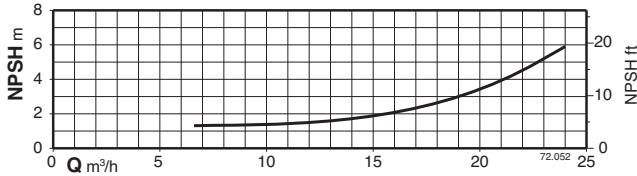
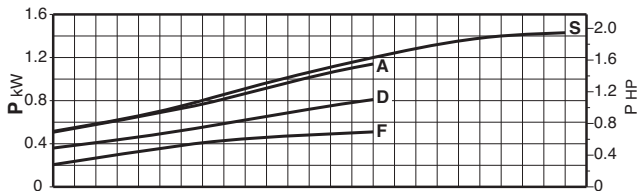
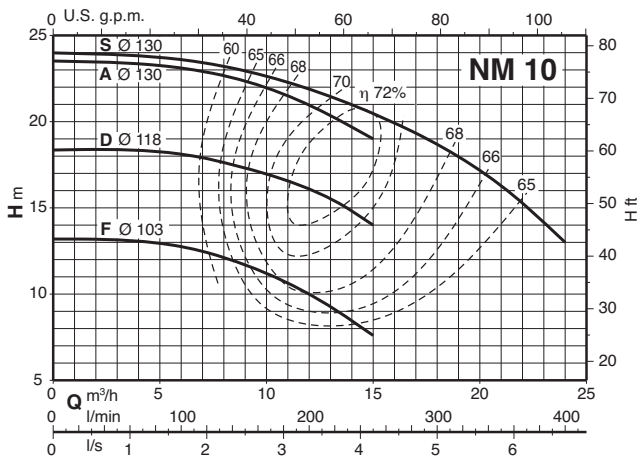

Curvas Características $n \approx 2900$ 1/min

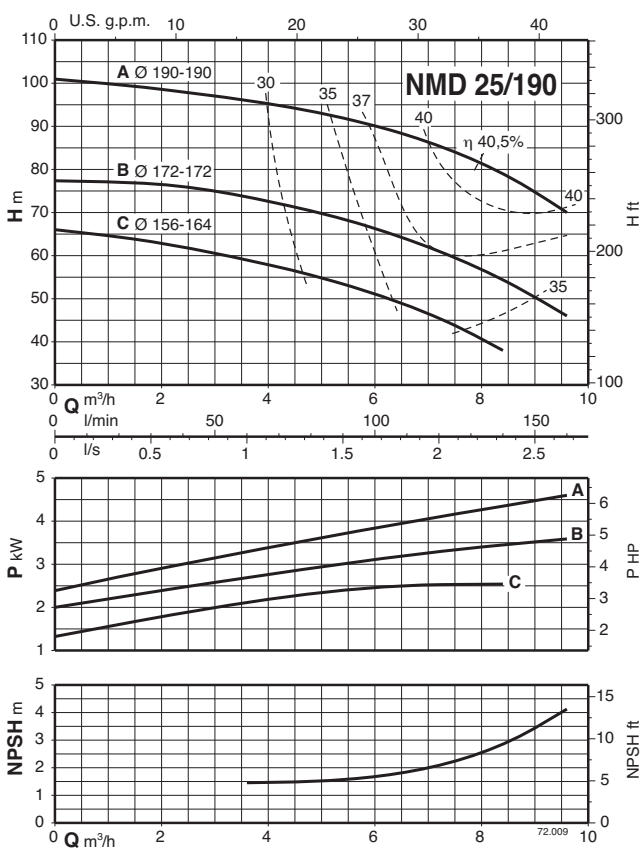
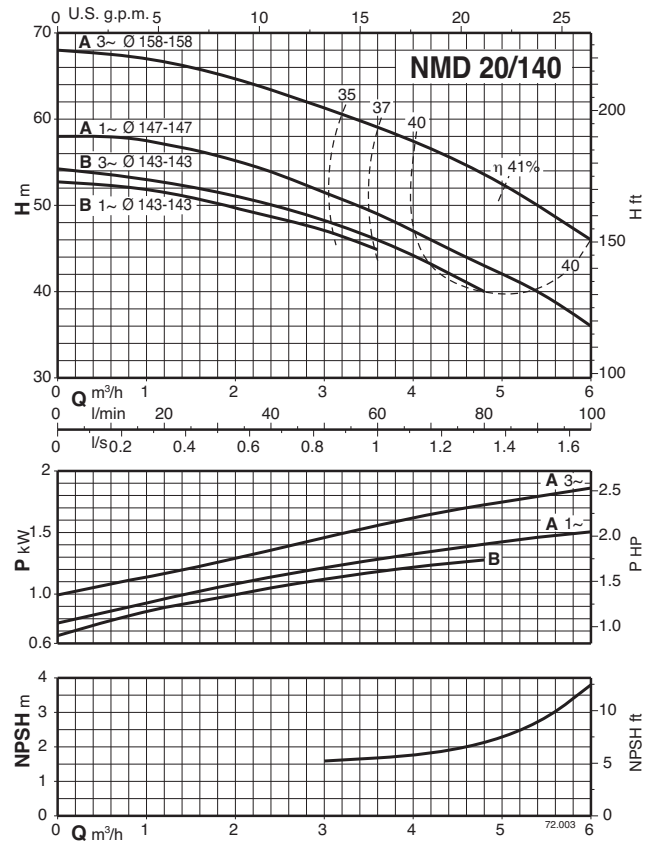
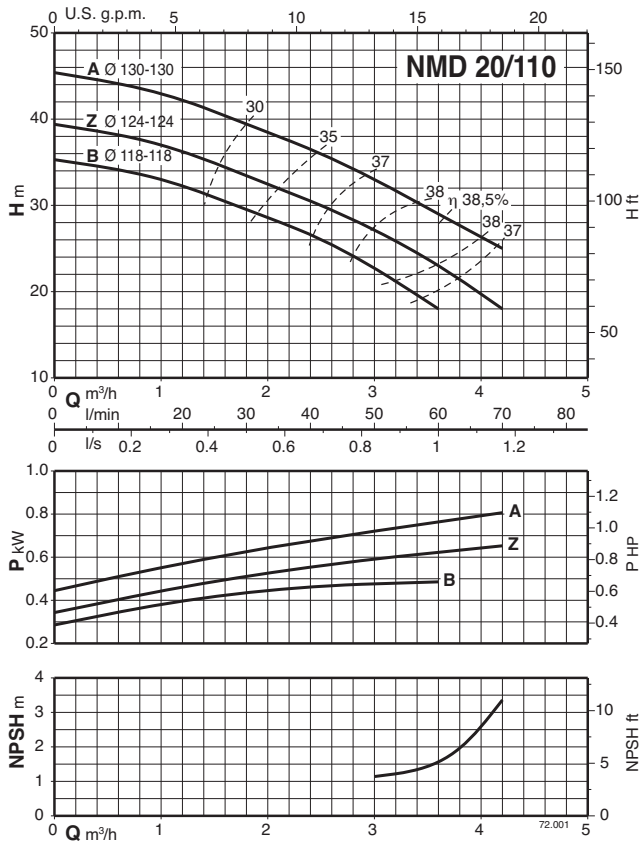

Curvas Características $n \approx 2900$ 1/min

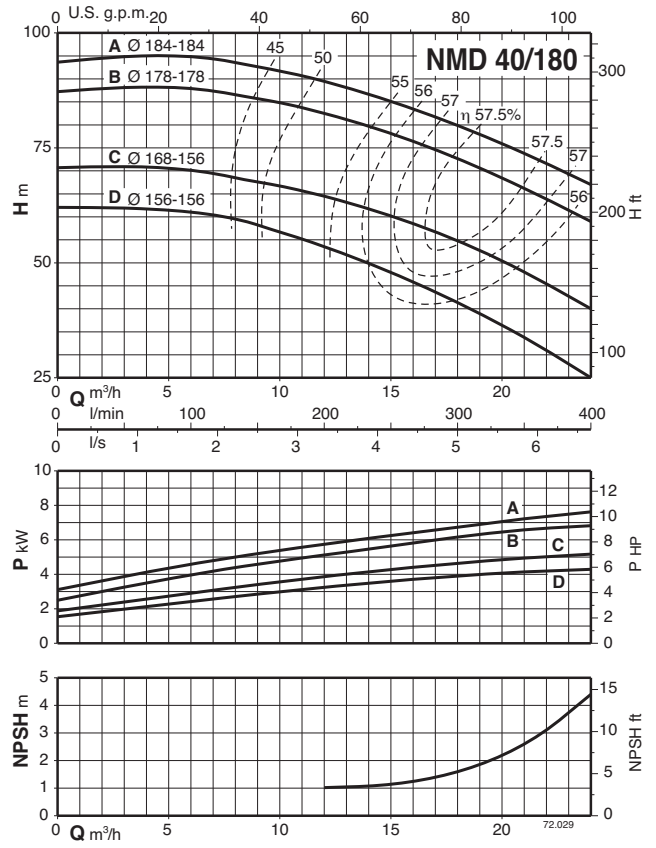
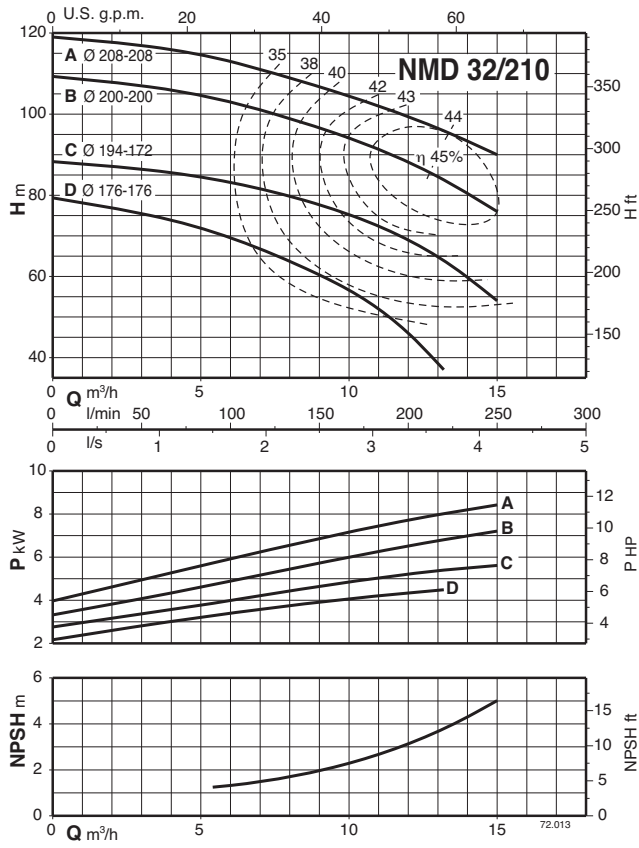

Dimensiones y pesos

1

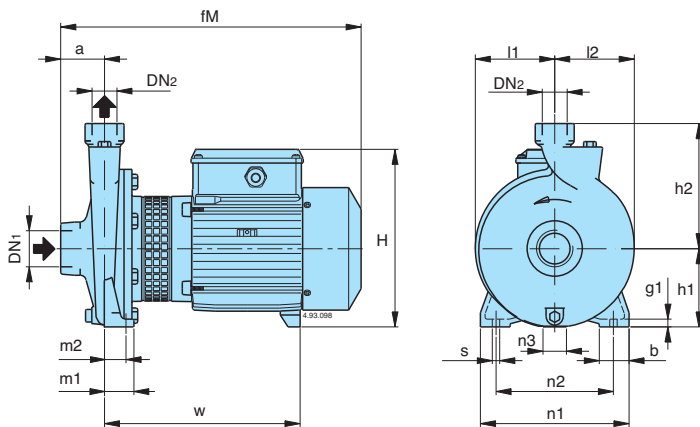

TIPO	NMM kg	NM kg	B-NM kg
NM 1/AE	8,7	8,6	
NM 2/B/A	14	13,1	
NM 2/S/A	14,2	13,3	
NM 2/A/A	15,1	14,2	
NM 3/CE	24	22,9	
NM 3/BE	26	25,1	
NM 3/A/A	30,4	29,1	
B- NM 20/160BE	19,9	18,4	21
B- NM 20/160AE	20,7	19,7	22,5
B- NM 25/12B/A	13,2	12,3	13,5
B- NM 25/12A/A	14,2	13,3	14,5
B- NM 25/160BE	20,4	19,7	22,8
B- NM 25/160AE	22,5	21,5	24
NM 25/20B/A		31,6	
NM 25/20A/A		40,9	
NM 25/20S/A		42,2	
B- NM 25/200B/A			35,7
B- NM 25/200A/A			43,7
B- NM 25/200S/A			45,2
NM 10/FE	19,3	18,5	
NM 10/DE	19,4	18,8	
NM 10/AE	20,2	19,3	
NM 10/SE	22,1	21,5	
NM 11/BE	24,7	24,1	
NM 11/A/A		28,1	
NM 12/D/A		33,5	
NM 12/C/A		42	
NM 12/A/A		43,5	
B- NM 17/HE	23	22,2	29,2
B- NM 17/GE	24,2	23,2	30,2
B- NM 17/F/A		28,2	35,2
B- NM 17/D/A		36,2	43,2

B-NM	NM	DN1 ISO 228	DN2 ISO 228	mm																
				a	fM	h1	h2	H	m1	m2	n1	n2	n3	b	s	l1	l2	w	g1	
	NM 1/AE	G 1	G 1	40	261	80	132	176	40	32	170	140	17	35	9,5	77	81	171	10	
	NM 2/A/A-S/A-B/A	G 1	G 1	45	305	95	150	207	40	32	190	160	17	35	9,5	87	90	203	10	
	NM 3/BE-CE NM 3/A/A	G 1	G 1	50	375 415	112	180	240	55	43	245	205	37	45	11,5	110	113	244 284	12	
B- NM 20/160AE-BE	NM 20/160AE-BE	G 1 1/4	G 3/4	53	375	100	150	228	37,5	27,5	190	150	30	38	9,5	102	102	246	10	
B- NM 25/12A/A-B/A	NM 25/12A/A-B/A	G 1 1/2	G 1	56	313	90	140	199	37,5	27,5	170	130	9	38	9,5	85	88	195	10	
B- NM 25/160AE-BE	NM 25/160AE-BE	G 1 1/2	G 1	56	380	100	160	228	37,5	27,5	190	150	30	38	9,5	102	102	246	10	
	NM 25/20B/A NM 25/20A/A-S/A	G 1 1/2	G 1	63	433 460	125	180	253 263	45	32,5	245	200	49 42	45	11,5	125	125	291 295	11	
B- NM 25/200B/A B- NM 25/200A/A-S/A		G 1 1/2	G 1	63	445 460	125	180	253 263	45	32,5	245	200	49 42	45	11,5	125	125	303 295	11	
	NM 10/SE-AE-DE-FE	G 2	G 1 1/4	63	382	100	150	228	50	35	190	140	30	50	13	90	97	239	14	
	NM 11/BE NM 11/A/A	G 2	G 1 1/4	70	400 440	112	170	240	50	35	210	160	37	50	15	103	110	247 287	14	
	NM 12/D/A NM 12/A/A-C/A	G 2	G 1 1/4	70	440 470	132	190	260 270	50	35	240	190	47 45	50	15	125	127	287 300	14	
B- NM 17/GE-HE B- NM 17F/A B- NM 17D/A	NM 17/GE-HE NM 17F/A NM 17D/A	G 2 1/2	G 2 1/2	80	417 457 480	112	160	240 250	50	35	210	160	37 20	50	14	96	113	257 287 295	14	

Dimensiones y pesos

NMD 20/110

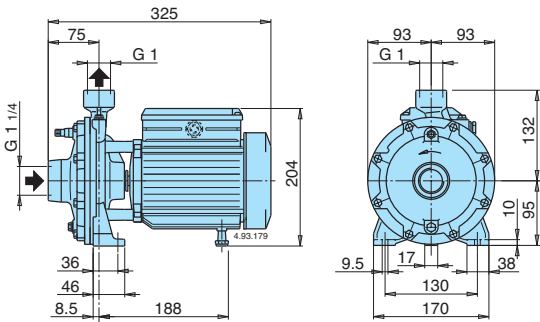

TIPO	NMDM kg	NMD kg	B-NMD kg
B- NMD 20/110B/A	13	12,1	13,4
B- NMD 20/110Z/A	14	13	14,2
B- NMD 20/110A/A	15,1	14,2	17,4

NMD 20/140 NMD 25/190

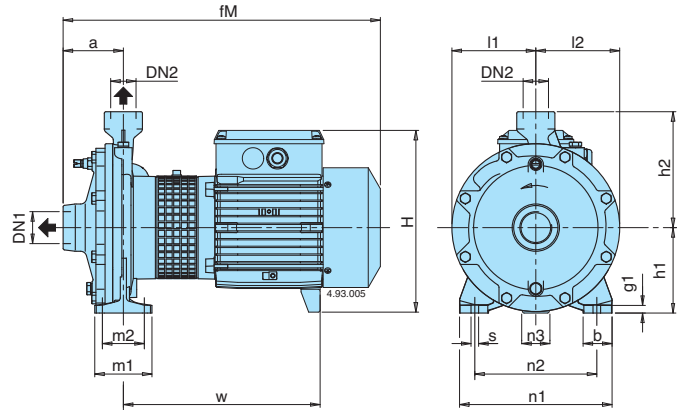

TIPO	NMDM kg	NMD kg	B-NMD kg
B- NMD 20/140BE	23,9	22,7	25,2
B- NMD 20/140AE	25,2	24,8	27,6
B- NMD 25/190C/A		42	45,7
B- NMD 25/190B/A		49,7	54
B- NMD 25/190A/A		51,5	55,5

B-NMD	NMD	DN1 ISO 228	DN2 ISO 228	mm																
				a	fM	h1	h2	H	m1	m2	n1	n2	n3	b	s	l1	l2	w	g1	
B- NMD 20/140AE-BE	NMD 20/140AE-BE	G 1 1/4	G 1	80	417	112	152	243	75	55	200	160	37	38	9,5	110	110	256	10	
B- NMD 25/190C/A	NMD 25/190C/A	G 1 1/2	G 1	97	487	140	180	268	100	70	240	190	50	49	50	14	133	133	314	13
B- NMD 25/190A/A-B/A	NMD 25/190A/A-B/A																			

NMD 32/210 NMD 40/180

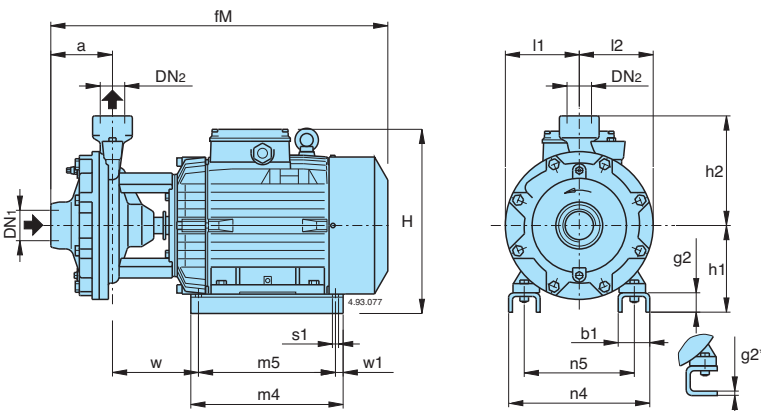

TIPO	NMD kg	B-NMD kg
B- NMD 32/210D/A	60,5	66,5
B- NMD 32/210C/A	71	77
B- NMD 32/210B/A	77	82,5
B- NMD 32/210A/A	99	105
B- NMD 40/180D/A	59,5	65,5
B- NMD 40/180C/A	70	76
B- NMD 40/180B/A	76	81,5
B- NMD 40/180A/A	97	102

B-NMD	NMD	DN1 ISO 228	DN2 ISO 228	mm																
				a	fM	h1	h2	H	m4	m5	n4	n5	w1	b1	s1	l1	l2	w	g2	
B- NMD 32/210D/A	NMD 32/210D/A	G 2	G 1 1/4	110	530	155	215	293	205	175	194	140		54	10			139	6*	
B- NMD 32/210B/A -C/A	NMD 32/210B/A -C/A			110	550	150	215	310	280	250	258	190	15	68	12	150	150	108	38	
B- NMD 32/210A/A	NMD 32/210A/A			110	625	175		355	298	268	286	216		70	12			152	38	
B- NMD 40/180D/A	NMD 40/180D/A	G 2	G 1 1/2	121	535	155	215	293	205	175	194	140		54	10			133	6*	
B- NMD 40/180B/A -C/A	NMD 40/180B/A -C/A			121	555	150	215	310	280	250	258	190	15	68	12	145	145	102	38	
B- NMD 40/180A/A	NMD 40/180A/A			121	630	170		355	298	268	286	216		70	12			145	38*	

NM

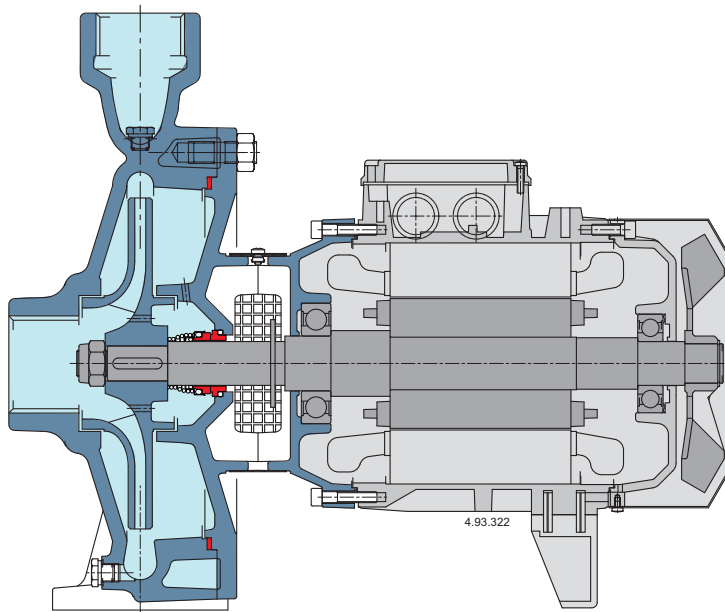

Diseño compacto

El diseño compacto permite una fácil instalación incluso en espacios reducidos.

Robustez

La estructura mecánica de las partes hidráulicas en contacto con el líquido bombeado están dimensionadas para garantizar la máxima resistencia a la tensión mecánica.

Diseño exclusivo

Un innovador protector patentado evita el contacto con las partes rotantes, lo que demuestra la protección para el usuario final mientras le permite la inspección del sello mecánico.

Fiabilidad

El cojinete y el eje están diseñados para asegurar la reducción de la tensión, proporcionando alta fiabilidad en todas las condiciones.

Características constructivas

NMD

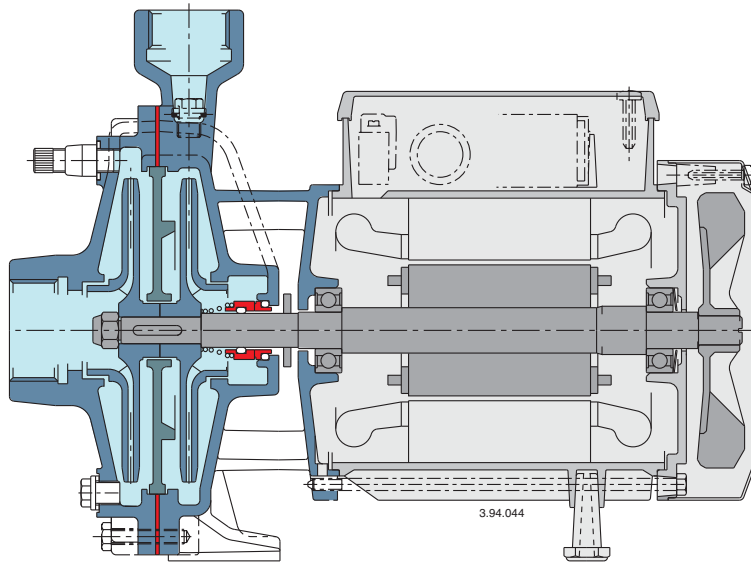

Flexibilidad

La opción de elegir entre el hierro fundido y Materias bronce para las partes hidráulicas en contacto con el líquido bombeado permite bombas de la serie NMD a ser seleccionadas para su uso con diferentes tipos de líquidos.

Robustez

La estructura mecánica de las partes hidráulicas en contacto con el líquido bombeado están dimensionadas para garantizar la máxima resistencia a la tensión mecánica.

Fiabilidad

El cojinete y el eje están diseñados para asegurar la reducción de la tensión, proporcionando alta fiabilidad en todas las condiciones de funcionamiento.